

User's Information Manual for

Brute®

Modulating Boiler
Model NTH
Sizes 080-210 MBTU/h

FOR YOUR SAFETY: This product must be installed and serviced by a professional service technician, qualified in hot water boiler and heater installation and maintenance. Improper installation and/or operation could create carbon monoxide gas in flue gases which could cause serious injury, property damage, or death. Improper installation and/or operation will void the warranty.

⚠ WARNING

If the information in this manual is not followed exactly, a fire or explosion may result causing property damage, personal injury or loss of life.

Do not store or use gasoline or other flammable vapors and liquids in the vicinity of this or any other appliance.

WHAT TO DO IF YOU SMELL GAS

- Do not try to light any appliance.
- Do not touch any electrical switch; do not use any phone in your building.
- Immediately call your gas supplier from a nearby phone. Follow the gas supplier's instructions.
- If you cannot reach your gas supplier, call the fire department.

Installation and service must be performed by a qualified installer, service agency, or gas supplier.

⚠ AVERTISSEMENT

Assurez-vous de bien suivre les instructions données dans cette notice pour réduire au minimum le risque d'incendie ou d'explosion ou pour éviter tout dommage matériel, toute blessure ou la mort.

Ne pas entreposer ni utiliser d'essence ni d'autres vapeurs ou liquides inflammables dans le voisinage de cet appareil ou de tout autre appareil.

QUE FAIRE SI VOUS SENTEZ UNE ODEUR DE GAZ:

- Ne pas tenter d'allumer d'appareils.
- Ne touchez à aucun interrupteur. Ne pas vous servir des téléphones dans le bâtiment où vous vous trouvez.
- Appelez immédiatement votre fournisseur de gaz depuis un voisin. Suivez les instructions du fournisseur.
- Si vous ne pouvez rejoindre le fournisseur de gaz, appelez le service des incendies.

L'installation et l'entretien doivent être assurés par un installateur ou un service d'entretien qualifié ou par le fournisseur de gaz.

CONTENTS

Familiarizing yourself to the Brute2
FOR YOUR SAFETY,
PLEASE READ THIS BEFORE OPERATING.....3
 What to Do If You Smell Gas3
POUR VOTRE SÉCURITÉ,
LISEZ AVANT DE METTRE EN MARCHÉ3
Que Faire si Vous Sentez une Odeur de Gaz3
 Lighting the Unit.....4
 Turning Off the Gas to the Unit4
Instructions de Mise en Marche.....5
Fermeture de l’Alimentation en Gaz.....5
 Shutting Down the Brute6
 Restarting the Brute6
 In the Event of Power Failure6
THE USER INTERFACE AND ON/OFF SWITCH.....7
 About Lockouts, Holds, and Alerts11
 Care, Inspection, and Service.....12



FAMILIARIZING YOURSELF TO THE **Brute®**

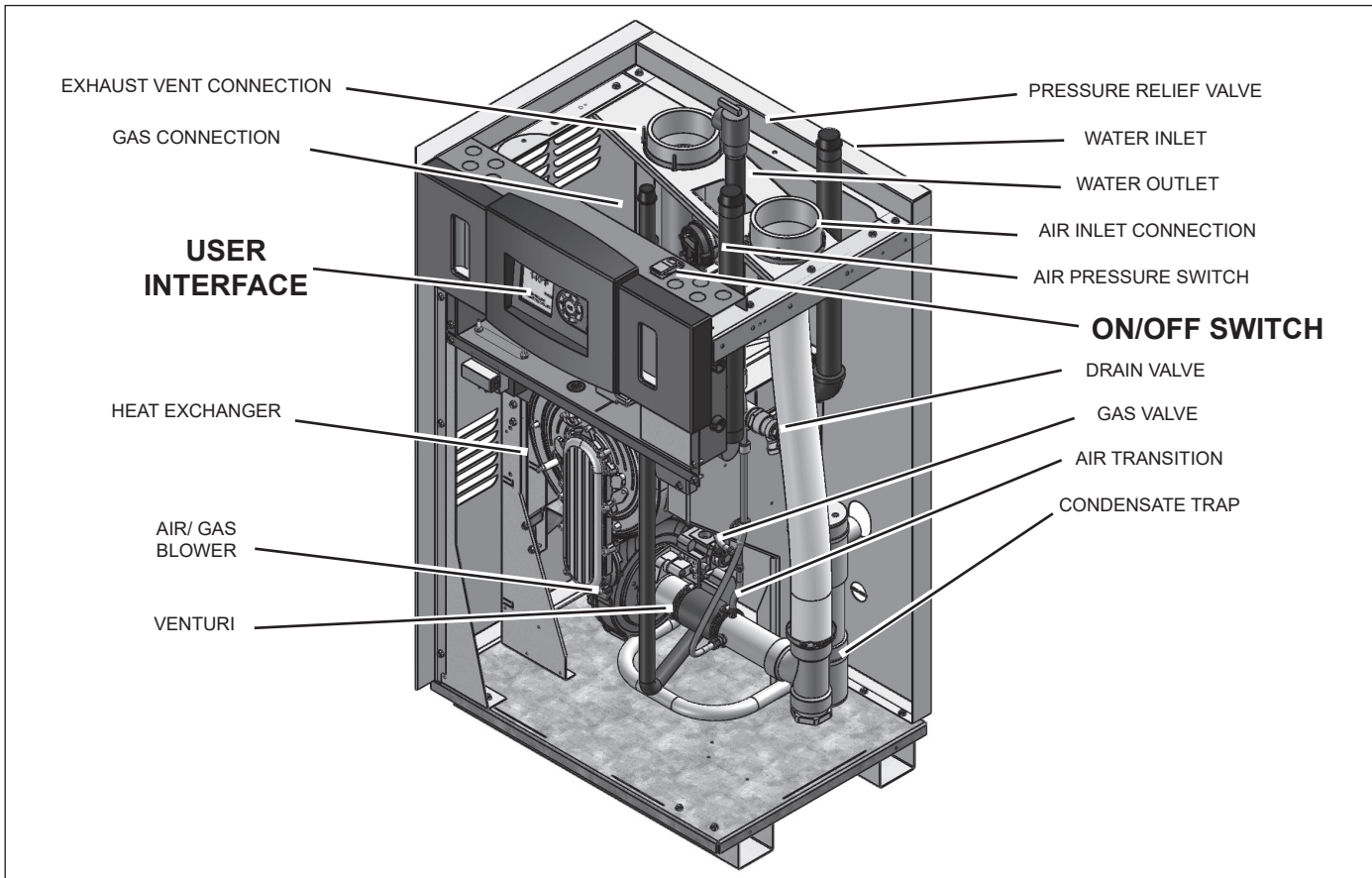

Sizes available are 080-210 MBTU/h. This illustration is of the 150 -210 MBTU/h
 Shown without jacket. Internal components will vary slightly between sizes, but the User Interface & On/Off Switch remain the same.

**FOR YOUR SAFETY -
PLEASE READ THIS BEFORE OPERATING****WARNING**

If you do not follow these instructions exactly, a fire or explosion may result, causing property damage, personal injury or loss of life.

- A. This unit does not have a pilot. It is equipped with an ignition device which automatically lights the burner. Do not try to light the burner by hand.
- B. **Before operating the unit**, check for any smell of gas in the area around it. Be sure to smell next to the floor, because some gas is heavier than air and will settle near the floor.
- C. Use only your hand to turn the handle on the gas valve. Never use tools. If the valve handle will not turn by hand, don't try to repair it. Call a qualified service technician. If you force the valve or try to repair it, this may result in a fire or explosion.
- D. Do not use this unit if any part has been under water. Immediately call a qualified service technician to inspect the unit. Any part of the control system or any gas control which has been under water must be replaced.

WHAT TO DO IF YOU SMELL GAS

- Do not try to light any appliance or device that uses gas.
- Do not touch any electrical switch. Do not use any phone in your building.
- Immediately call your gas supplier from a neighbor's phone. Follow the gas supplier's instructions.
- If you cannot reach your gas supplier, call the fire department.

**POUR VOTRE SÉCURITÉ,
LISEZ AVANT DE METTRE EN MARCHÉ****AVERTISSEMENT**

Quiconque ne respecte pas à la lettre les instructions dans la présente notice risque un début d'incendie ou une explosion entraînant des dommages, des blessures ou la mort.

- A. Cet appareil est muni d'un dispositif d'allumage qui allume automatiquement la veilleuse. Ne tentez pas d'allumer la veilleuse manuellement.
- B. **Avant de faire fonctionner**, reniflez tout autour de l'appareil pour déceler une odeur de gaz. Reniflez près du plancher, car certains gaz sont plus lourds que l'air et peuvent s'accumuler au niveau du sol.
- C. N'utilisez que votre main pour fermer la soupape d'arrêt de gaz. N'utilisez jamais d'outils. Si la poignée de la valve ne tourne pas manuellement, ne tentez pas de la réparer. Communiquez avec un technicien de service qualifié. Le fait de forcer ou de tenter de réparer la poignée pourrait causer un incendie ou une explosion.
- D. N'utilisez pas cet appareil s'il a été plongé dans l'eau, même partiellement. Faites inspecter l'appareil par un technicien qualifié et remplacez toute partie du système de contrôle et toute commande qui ont été plongées dans l'eau.

QUE FAIRE SI VOUS SENTEZ UNE ODEUR DE GAZ

- Ne pas tenter d'allumer d'appareil.
- Ne toucher à aucun interrupteur; ne pas vous servir des téléphones se trouvant dans le bâtiment.
- Appelez immédiatement votre fournisseur de gaz depuis un voisin. Suivez les instructions du fournisseur.
- Si vous ne pouvez rejoindre le fournisseur, appelez le service des incendies.

LIGHTING THE UNIT

1. STOP! Read the safety information listed above.
2. Set the thermostat to the lowest setting.
3. Turn off all electric power to the unit.
4. This unit is equipped with an ignition device which automatically lights the burner. Do not try to light the burner by hand.
5. Remove the front access panel.
6. Turn off the manual gas valve. The valve is off when the valve handle is at a right angle to the gas pipe.
7. Wait five minutes to allow any gas to clear. Smell for gas, including the area near the floor. If you do smell gas, STOP! Follow Step B in the safety information listed above. If you don't smell gas, go to the next step.
8. Slowly turn the manual gas valve to "ON." The handle on the valve will be parallel to the gas pipe.
9. Replace the front panel.
10. Turn on the electric power to the unit.
11. Set the thermostat to the desired setting.
12. If the unit will not operate, follow the instructions in "Turning Off the Gas to the Unit" and call your service technician or gas supplier.

TURNING OFF THE GAS TO THE UNIT

1. Before doing any service work, turn off all electric power to the unit.
2. Set the thermostat to the lowest setting.
3. Remove the front access panel.
4. Turn off the manual gas valve. The valve is off when the valve handle is at a right angle to the gas pipe.
5. Replace the front panel.

⚠ WARNING

Carbon Monoxide Hazard

This product burns gas to produce heat. The appliance must be properly installed, operated, and maintained to avoid exposure to appreciable levels of carbon monoxide and the installer is required to confirm that at least one carbon monoxide alarm is installed in the living space before the appliance is put into operation.

It is important for carbon monoxide alarms to be installed, maintained, and replaced following the alarm manufacturer's instructions and applicable local codes.

⚠ AVERTISSEMENT

Danger lié au monoxyde de carbone

Ce produit brûle des gaz pour produire de la chaleur. L'appareil requiert une installation, un fonctionnement et une maintenance adéquates afin d'éviter l'exposition à des niveaux appréciables de monoxyde de carbone; l'installateur est requis de confirmer qu'au moins une alarme de détection de monoxyde de carbone est installée dans l'espace de vie avant que l'appareil ne soit mis en service.

Il importe que les alarmes de détection de monoxyde de carbone soient installées, maintenues et remplacées selon les directives du manufacturier et les codes locaux applicables.

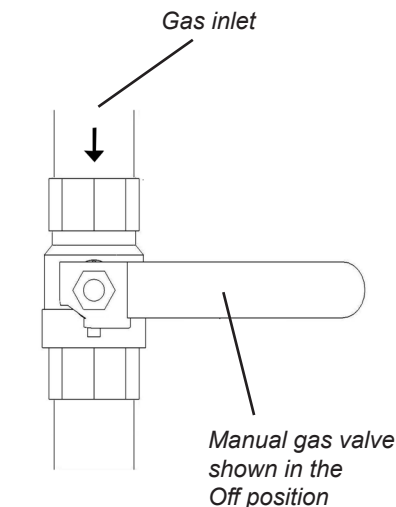

Manual Gas Valve

INSTRUCTIONS DE MISE EN MARCHÉ

1. ARRÊTEZ ! Lisez les instructions de sécurité sur la portion supérieure.
2. Réglez le thermostat à la température la plus basse.
3. Coupez l'alimentation électrique de l'appareil.
4. Cet appareil est doté d'un dispositif d'allumage qui allumera automatiquement le brûleur. Ne tentez pas d'allumer le brûleur manuellement.
5. Retirez le couvercle avant.
6. Mettez la soupape d'arrêt de gaz à „OFF”. La valve est en position „OFF” lorsque la poignée se trouve à angle droit du tuyau de gaz.
7. Attendez cinq minutes afin que le gaz se dissipe. Si vous croyez sentir une odeur de gaz, ARRÊTEZ ! Reportez-vous aux instructions B ci-dessus, sur cette étiquette. S'il n'y a pas d'odeur de gaz, passez à la prochaine étape.
8. Remettez lentement la soupape d'arrêt de gaz en position „ON”. La poignée sera parallèle au tuyau de gaz.
9. Remplacez le couvercle avant.
10. Rétablissez l'alimentation électrique à l'appareil.
11. Réglez le thermostat à la température désirée.
12. Si l'appareil ne fonctionne pas, suivez les directives relatives à la fermeture de l'alimentation en gaz et communiquez avec votre technicien de service ou le fournisseur de gaz.

FERMETURE DE L'ALIMENTATION EN GAZ

1. Coupez toute alimentation électrique à l'appareil si celui-ci doit faire l'objet d'un entretien.
2. Réglez le thermostat au réglage le plus bas.
3. Retirez le couvercle d'accès au panneau de commande.
4. Mettez la soupape d'arrêt de gaz à „OFF”. La valve est en position „OFF” lorsque la poignée se trouve à angle droit du tuyau de gaz.
5. Remplacez le couvercle d'accès au panneau de commande.

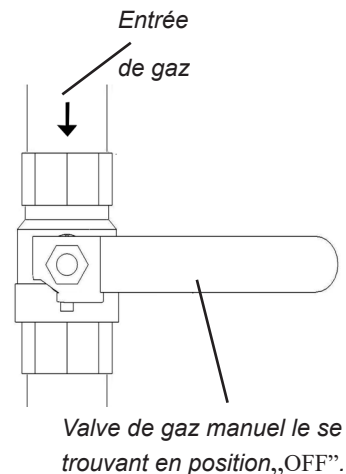

Valve de Gaz Manuel

SHUTTING DOWN THE BRUTE

It may sometimes be necessary to shut down the Brute. Here are the steps required to do this:

1. Switch off the main electrical disconnect switch.
2. Open the front cover and close the main manual gas valve.
3. If freezing is anticipated, drain the Brute. (Also be sure to protect the piping in the building from freezing.)

The steps listed above may require qualified service personnel.

RESTARTING THE BRUTE

It may be necessary to restart the Brute – for example, after a power interruption. Here are the steps required to do this:

1. Reset any errors using the user interface. See the section on “About Lockouts, Holds, and Alerts.”
2. Turn up the thermostat to call for heat.
3. In approximately 2 seconds, the blower will operate. Ignition should occur after 35-40 seconds. It may take as long as 2-1/2 minutes.
4. If ignition does not occur, wait 5 minutes and then repeat steps 1 through 3.
5. If, after three attempts, the unit still does not light, shut down the boiler and call your service technician.

If the unit has been drained, follow these steps:

1. See the “Installation and Operation Manual” for instructions on filling and purging the unit.
2. Remove the front door. Turn on the gas shutoff valve.
3. Switch on the main electrical disconnect switch. The pump and blower will start, and the igniter will be energized. After 35 seconds the gas valve will be energized, and ignition will occur. If ignition does not occur within 2-1/2 minutes switch “off” the main disconnect switch, wait 5 minutes and switch it “on” again. If after three attempts ignition does not occur, shut down the unit and call for service.

IN THE EVENT OF POWER FAILURE

The Brute will not operate during an electrical power outage. If there is an extended power outage with danger of freezing, then the Brute (and all other water systems) should be completely drained. Before draining the unit, turn off the gas and turn off the main power switch. When you replace the unit in service, refer to the “Installation and Operation Manual” for instructions on filling and purging.

THE USER INTERFACE AND ON/OFF SWITCH

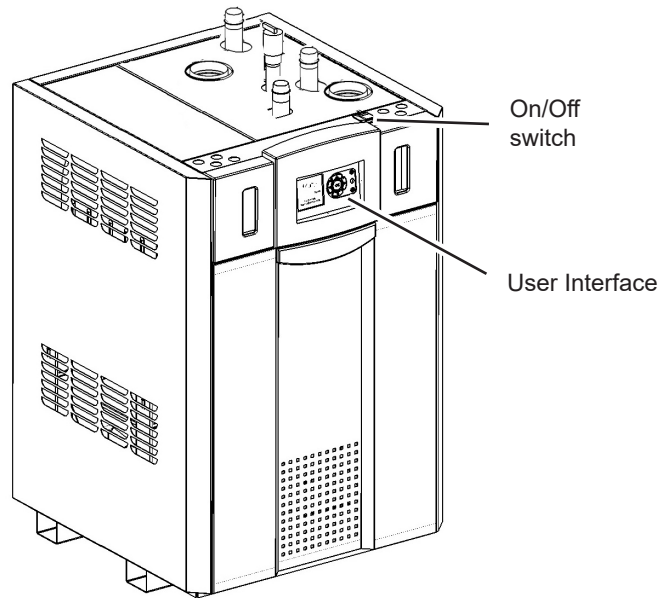

The Brute has two control components:



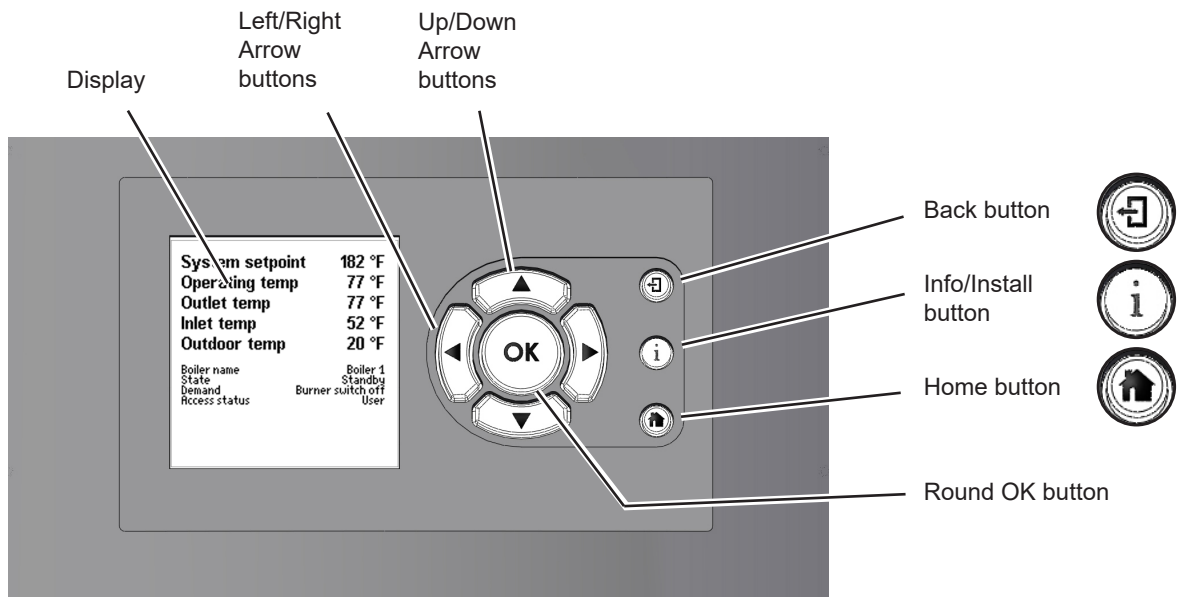

- the User Interface
- the On/Off switch

The User Interface is used to send commands to the boiler controller and to display operating and setup information sent from the boiler controller.

The drawing below shows the main parts of the user interface and the following table lists the functions of the various parts of the user interface.



User Interface

Up/ Down Arrow buttons		Use these to go to the choice you want to select in the display area, then press the round OK button.
Left/ Right Arrow buttons		Use these to go to the choice you want to select in the display area, then press the round OK button.
Back button		Use this to go back to the previous display.
Info/ Install button		Press this button at any time to go to the sub-menus that allow you to set up and monitor the controller.
Home button		Press this button at any time to go back to the Home display. (See the section on “Home Display.”)
Round OK button		Use the round OK button to confirm a value or action.

Button Functions on User Interface

Home Screen Button

When the boiler is operating normally, the boiler controller will display the Home Screen on the display. Or you can press the Home Screen Button  at any time to get to this Home Screen.

System setpoint	182 °F
Operating temp	77 °F
Outlet temp	77 °F
Inlet temp	52 °F
Outdoor temp	20 °F
Boiler name	Boiler 1
State	Standby
Demand	Burner switch off
Access status	User

Home Screen

The Home Screen has three sections:

- The upper section of this screen shows the most important operating information. In this example, the display is showing the system setpoint, the operating temperature, the outlet and inlet temperatures for the water entering and leaving the boiler, and the outdoor temperature.

(Note that the five lines at the top of the screen are customizable, and may be arranged differently on your system.)

- The central section shows some additional operating and setup information. In this case, this area lists the boiler name, boiler state, current demand, and the current password level (the “access status”).
- The lower section shows any current lockouts, holds, or alerts.

Info/Install Button 

The Info/Install Button will change the display to show the six sub-menus available.

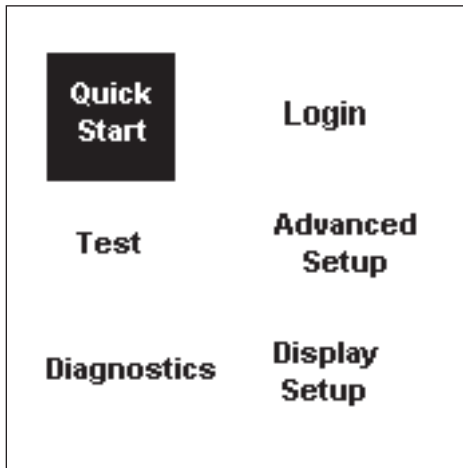

Info/ Install Screen

- To move from one choice to another, use the Left- and Right-Arrow buttons or the Up- and Down-Arrow buttons.
- Once you have highlighted the choice you want, press the round OK button.

Here are the functions you can reach from the Info/ Install display screen:

Quick Start	This menu gives you an easy way to check or change the most common settings on the unit.
Login	If you want to change a setup value or function, and the system requires a password, you can enter it here.
Test	These parameters let you turn the burner on and off, and control the fan and pump speeds.
Advanced Setup	The sub-menus listed here allow you to set up most of the functions on the controller.
Diagnostics	Use the Diagnostics to check the status of the sensors and the digital inputs and outputs. The system also records a history of lockouts and alarms.
Display Setup	You can use this option to adjust the contrast of the display or change the items which appear at the top of the Home display.

Quick Start Menu (found in the Info/Install Screen)



Once the unit has been installed and set up, the Quick Start menu provides a simple way to change the most common settings used in a typical installation.

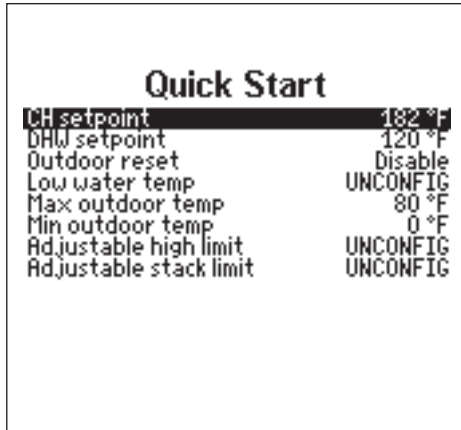

Quick Start Menu

Example - Changing the CH (Central Heat) Setpoint

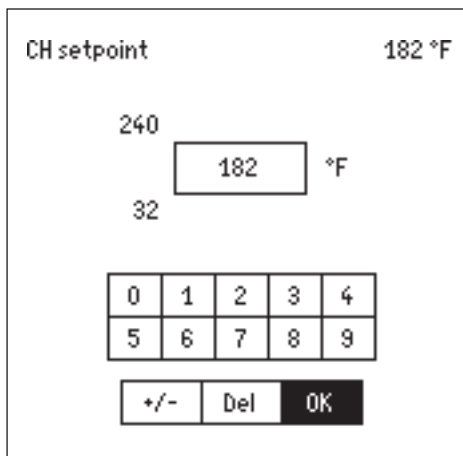

Changing the CH Setpoint

- On the Quick Start menu, use the Up- and Down-Arrows to go to the line for CH Setpoint. Press the large OK button to select the line.
- Use the Up- and Down-Arrow buttons to select the value you want.
- Press the round OK button to enter the new value.

ABOUT LOCKOUTS, HOLDS, AND ALERTS

The system responds to three kinds of trouble indications:

- A "lockout" is caused by a serious problem that might involve a safety issue. Once the controller enters a lockout, the burner will shut down, and will not be allowed to run again until the cause of the problem is corrected, and you reset the control system.
- The system may enter a "hold" for a period of time before locking out. This allows the controller to see if the error becomes resolved prior to the hard lockout.
- An "alert" indicates that some feature of the control system's operation was not correct, delayed, or waiting for a response. This does not necessarily indicate a problem.

If a problem occurs, the system will present a note across the bottom of the screen:

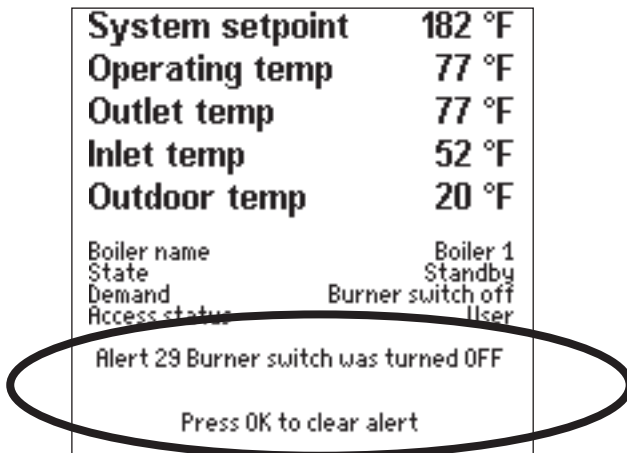

Example - Lockout or Hold Indication

Correct the problem, then press the round OK button to reset the control.

Each error message includes a number. For a more detailed description of each message, see the "Installation and Operation Manual."

GENERAL CARE

Keep the area around the Brute clear and free from combustible materials, gasoline and other flammable vapors and liquids. Clean the jacket surfaces with a damp cloth and mild soap. Do not use flammable cleaning materials. Keep the vent terminal free of obstructions. Do not pile snow against the vent terminal.

ANNUAL INSPECTION AND SERVICE

You should visually inspect the vent pipe once a year. Should any corrosion or leaks exist, have the affected parts replaced.

Once each year a qualified service agency should conduct a detailed inspection of all flue product carrying areas of the boiler and vent system. Follow the service instructions in the “Installation and Operating Instructions Manual” for the Bradford White Brute.

Caution

Do not use this boiler if any part has been under water. Immediately call a qualified service technician to inspect the boiler. Any part of the control system and any gas control which has been under water must be replaced.

WARNING

If the unit overheats or the gas supply fails to shut off, do not turn off or disconnect the electrical supply to the pump. Instead, shut off the gas supply at a location external to the Brute.

En cas de surchauffe ou si l'admission de gaz ne peut être coupée, ne pas couper ni débrancher l'alimentation électrique de la pompe. Fermer plutôt le robinet d'admission de gaz à l'extérieur de l'appareil.

FOR SERVICE

Contact your installing contractor, gas utility, Bradford White dealer, or check www.bradfordwhite.com for the nearest authorized representative in your area.



H2360200B



200 Lafayette St.
Middleville, MI 49333
Warranty: (800) 531-2111

www.BradfordWhite.com

Litho in U.S.A. © Bradford White 23-10 Document 1253B