

Commercial eF Series[®] Ultra High Efficiency Gas Water Heater



Photo is of
EF-120T-500-3N

FEATURING:



The eF Series[®] Models feature:

- **ENERGY STAR[®] Qualified**—Models meet or exceed requirements for ENERGY STAR[®] per the latest ENERGY STAR[®] criteria revision.
- **Thermal Efficiency 94%**—Ultra High Efficiency results in less fuel consumption and greater hot water recovery.
- **Modulating Down-Fired Premix Power Burner**—A self compensating negative regulation system automatically increases or decreases fuel flow when a change in combustion air is detected. This provides the range for optimum combustion and efficiency with a 3:1 Turn Down Ratio (automatic high altitude compatibility up to 10,000 ft./3,048m.).
- **BMS Integration**—Via Modbus standard, BACnet[®] compatible via gateway kit.
- **ICON HD[®]**—Intelligent proven design combines temperature control, diagnostic codes, and system ignition functions into a single control board with a digital LCD display.
- **Vitraglas[®] Lining with Microban[®]**—An exclusively engineered enamel formula that provides superior tank protection from the corrosive effects of water; and with Microban[®] antimicrobial product protection to help prevent the growth of bacteria, mold and mildew on the surface of the tank lining.
- **Factory Installed Hydrojet[®] Sediment Reduction System**—Cold water inlet sediment reducing device helps prevent sediment build up in the tank.
- **Protective Powered Anodes**—Each eF Series[®] model is provided with 2 powered anode rods.
- **Venting Versatility**—The eF Series[®] can vent vertically or horizontally with 3", 4", or 6" (76mm, 102mm, or 152mm) PVC, CPVC, Polypropylene, Stainless Steel, or ABS (not approved for Canada) vent pipe, and is approved for direct vent closed combustion applications, or those applications that require inside air for combustion. The eF Series[®] is also approved for unbalanced venting, which means the air intake pipe doesn't have to be vented the same distance as the exhaust. Common vent kits available.
- **Submerged Combustion Chamber**—Minimizes radiant heat loss for better efficiency.
- **Three Pass Fire Tube Heat Exchanger System**—Provides maximum heat transfer surface area.
- **Ultra Quiet Operation.**
- **A Single Exhaust Pressure Switch.**
- **1" (25mm) NPT Side Connections for Space Heating.**
- **Sanitizing Capability**—Temperature setting up to 180°F (82°C).
- **Complies with the latest ultra-low NOx requirement (14 ng/J NOx limit for natural gas and 77ppm NOx limit for liquid propane).**
- **ASME Code Available on All Models.**
- **T&P Relief Valve**—Installed.
- **Low Restrictive Brass Drain Valve**—Durable tamper proof design (Alternative location available).

3 or 5-Year Limited Tank Warranties / 1-Year Limited Warranty on Component Parts.

For more information on warranty, please visit www.bradfordwhite.com

For products installed in USA, Canada, and Puerto Rico. Some states do not allow limitations on warranties.

See complete copy of the warranty included with the heater.

Microban[®] antimicrobial product protection helps prevent the growth of bacteria, mold and mildew that may affect the product. The built-in antimicrobial properties do not protect users or others from disease-causing organisms. Microban[®] is a registered trademark of Microban Products Company.

Commercial Gas High Efficiency Water Heater

eF Series® Additional Equipment Features:

Direct Spark Ignition—For improved operational dependability and durability.

Operation Mode—Two different digitally displayed operation modes have the capability of adjusting the temperature setting up to 180°F (82°C), and adjusting the degree setting (°F to °C, or °C to °F).

Service Mode—Eight different digitally displayed service screens can be easily cycled through by pressing the select button. There is the capability of adjusting the temperature setting up to 180°F (82°C), adjusting the degree setting (°F to °C, or °C to °F), locking the maximum temperature setting that can be adjusted in operation mode, displaying the temperature sensor reading, displaying the flame current, and displaying diagnostic codes.

Water Connections—Factory-installed true dielectric fittings extend water heater life and simplify water line connections.

Zero Inch Clearance—The eF Series® jacket is cool to the touch and is approved for zero inch clearance to combustibles for unsurpassed installation flexibility.

Hand Hole Cleanout—Allows inspection of tank interior and facilitates the removal of sediment deposits.

E.C.O.—A manual re-set Energy Cut Off (E.C.O) shuts off all gas in event of an overheat condition. The ECO is manually resettable.

Non-CFC Foam Insulation—Covers the sides, reducing the amount of heat loss. This results in less energy consumption, improved operation efficiencies and jacket rigidity.

3 in. (76mm.) Vent Pipe	EF-120T-400-3N(A) 399,999 BTU/Hr.		EF-120T-500-3N(A) 499,000 BTU/Hr.	
	Power Vent	Power Direct Vent	Power Vent	Power Direct Vent
Max. Intake Length	N/A	65 ft. (19.8m.)	N/A	65 ft. (19.8m.)
Max. Exhaust Length	65 ft. (19.8m.)	65 ft. (19.8m.)	65 ft. (19.8m.)	65 ft. (19.8m.)
4 in. (102mm.) Vent Pipe	EF-120T-400-3N(A) 399,999 BTU/Hr.		EF-120T-500-3N(A) 499,000 BTU/Hr.	
	Power Vent	Power Direct Vent	Power Vent	Power Direct Vent
Max. Intake Length	N/A	100 ft. (30.5m.)	N/A	100 ft. (30.5m.)
Max. Exhaust Length	100 ft. (30.5m.)	100 ft. (30.5m.)	100 ft. (30.5m.)	100 ft. (30.5m.)
6 in. (152mm.) Vent Pipe	EF-120T-400-3N(A) 399,999 BTU/Hr.		EF-120T-500-3N(A) 499,000 BTU/Hr.	
	Power Vent	Power Direct Vent	Power Vent	Power Direct Vent
Max. Intake Length	N/A	120 ft. (36.6m.)	N/A	120 ft. (36.6m.)
Max. Exhaust Length	120 ft. (36.6m.)	120 ft. (36.6m.)	120 ft. (36.6m.)	120 ft. (36.6m.)

Air intake cannot exceed exhaust by more than 30 ft. (9m) in any venting situation. Subtract 5 ft. (1.5m) for each additional 90° elbow.

eF Series® Optional Equipment Features:

- Common Vent Exhaust Kit PVC/CPVC p/n 415-54698-00
- Common Vent Exhaust Kit Polypropylene p/n 415-54706-00
- NSF Compliance Kit p/n 265-44542-04
- Optional Condensate Neutralizer Kit p/n A2123609
- BACnet® Gateway Kit p/n 415-53943-00

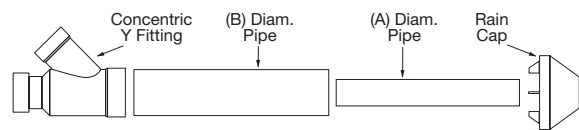
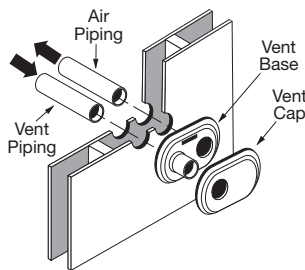

3" and 4" Concentric Vent Kits Part Identification

Concentric Vent Size	(A)	(B)
4 in. (102mm)	4.5 in. (114mm)	6.6 in. (168mm)
3 in. (76mm)	3 in. (76mm)	4.5 in. (114mm)

Low Profile Termination Kit Model Numbers

Description	Pipe O.D.	Hole Spacing (ctr to ctr)	IPEX System (1738 or 636)	IPEX Part Number
3" (76mm) Low Profile	3.5" (89mm) Low Profile	5.6" (142mm)	636	196985
3" (76mm) Low Profile	3.5" (89mm) Low Profile	5.6" (142mm)	1738	397985
4" (102mm) Low Profile	4.5" (114mm) Low Profile	5.6" (142mm)	636	196986
4" (102mm) Low Profile	4.5" (114mm) Low Profile	5.6" (142mm)	1738	397086

Appliance Numbers Approved for Concentric Termination Kits

Model	Description	Part Number	IPEX System (1738 or 636)	IPEX Part Number
EF120T(400,500)	3" (76mm) Concentric Termination	415-44069-01	636	196006 (PVC), 197009 (CPVC)
EF120T(400,500)	3" (76mm) Concentric Termination	—	1738	397006
EF120T(400,500)	4" (102mm) Concentric Termination	—	636	196021 (PVC), 197021 (CPVC)
EF120T(400,500)	4" (102mm) Concentric Termination	—	1738	397021

Commercial Gas High Efficiency Water Heater

eF Series® Models

NATURAL AND LIQUID PROPANE GAS

Meet or exceed ASHRAE 90.1 (latest edition). C.E.C. Listed

Model Number	Rated Nominal Volume		Input BTU/Hr. Input	Therm. Eff. %	A Floor to Top of Heater in.	B Jacket Dia. in.	C Floor to Front Hot Water Conn. in.	D Floor to Cold Water Conn. in.	E Floor to Gas Conn. in.	F Floor to Vent Conn. in.	G Floor to Air Intake Conn. in.	H Floor to T&P Conn. in.	J Floor to Top Hot Water Conn. in.	Water Conn. Dia. in.	Gas Conn. Dia. in.	Relief Valve Conn. in.	Approx. Shipping Weight lbs.
	U.S. Gal.	Imp. Gal.															
★ EF-120T-400-3N(A)	119	99	399,999	94.0	77 ¹ / ₈	33	61 ¹ / ₄	12 ¹ / ₄	73 ⁷ / ₈	6 ³ / ₄	71	58 ¹ / ₂	72 ¹ / ₂	1 ¹ / ₂	1	1	1,120
★ EF-120T-500-3N(A)	119	99	499,000	94.0	77 ¹ / ₈	33	61 ¹ / ₄	12 ¹ / ₄	74 ⁷ / ₈	6 ³ / ₄	71	58 ¹ / ₂	72 ¹ / ₂	1 ¹ / ₂	1	1	1,135

Model Number	Rated Nominal Volume		Input kW/Hr. Input	Therm. Eff. %	A Floor to Top of Heater mm.	B Jacket Dia. mm.	C Floor to Front Hot Water Conn. mm.	D Floor to Cold Water Conn. mm.	E Floor to Gas Conn. mm.	F Floor to Vent Conn. mm.	G Floor to Air Intake Conn. mm.	H Floor to T&P Conn. mm.	J Floor to Top Hot Water Conn. mm.	Water Conn. Dia. mm.	Gas Conn. Dia. mm.	Relief Valve Conn. mm.	Approx. Shipping Weight kgs.
	Liters																
★ EF-120T-400-3N(A)	450		117.2	94.0	1959	838	1556	311	1877	171	1804	1486	1842	38	25	25	508
★ EF-120T-500-3N(A)	450		146.5	94.0	1959	838	1556	311	1902	171	1804	1486	1842	38	25	25	515

For propane gas models change suffix "N" to "X". **Example:** EF-120T-400-3X

(A) ASME - All models are available with ASME construction. To order ASME construction add the (A) to the end of the model number.

Example: EF-120T-500-3NA

For 5 year warranty models, change suffix "3" to "5" **Example:** EF-120T-500-5N

Note: The weight is the same for both ASME and Non-ASME models.

All models comply with the latest ultra-low NOx requirements of 14 ng/J or less for natural gas and 77ppm NOx or less for liquid propane.

14.0" (356mm) w.c. maximum static, 4.5" (114mm) w.c. minimum running (recommend 7.0" (178mm) w.c. minimum running).

The water heater must be wired to 120VAC, 60Hz, 15A power supply.

★ = ENERGY STAR® Qualified.

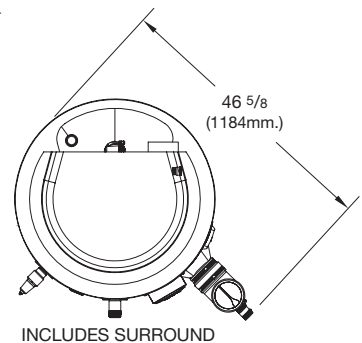
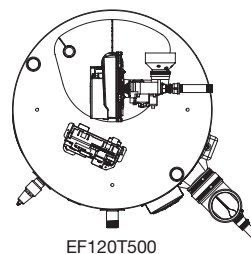
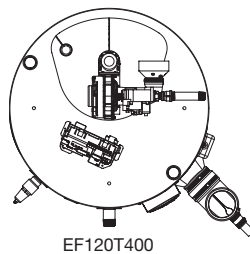
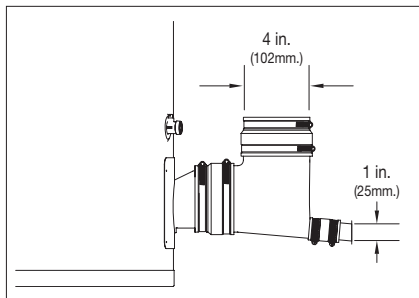
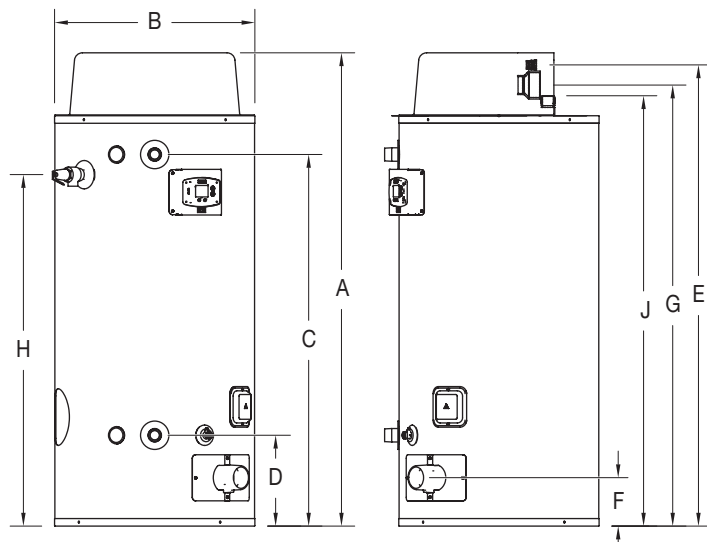

Recovery Data

Model Number	GPH Recovery at Degree Rise*												LPH Recovery at Degree Rise*											
	30°F	40°F	50°F	60°F	70°F	80°F	90°F	100°F	110°F	120°F	130°F	140°F	17°C	22°C	28°C	33°C	39°C	44°C	50°C	56°C	61°C	67°C	72°C	78°C
EF-120T-400-3N(A)	1520	1140	912	760	651	570	507	456	414	380	351	326	5754	4315	3452	2877	2464	2158	1919	1726	1567	1438	1329	1234
EF-120T-500-3N(A)	1893	1420	1136	947	811	710	631	568	516	473	437	406	7166	5375	4300	3585	3070	2688	2389	2150	1953	1790	1654	1537

Commercial Gas High Efficiency Water Heater

Sample Specification

The water heater shall be a Bradford White model EF-_____ with a rated storage capacity of not less than _____ gallons/ liters, a minimum gas input of _____ BTU/Hr., a minimum recovery of _____ GPH/LPH at 100°F (56°C) temperature rise, and a Thermal Efficiency Rating of _____%. It shall be design certified by CSA International (formerly AGA and CGA) for 180°F (82°C) application, either with or without a separate storage tank. The tank shall be lined with Vitraglas® vitreous enamel with Microban® antimicrobial technology and shall have a bolted hand hole cleanout. The tank shall have two powered anode rods. This water heater shall be equipped with stainless steel cold water inlet, Hydrojet® Sediment Reduction System. The heater shall be insulated with Non-CFC foam. This water heater shall be equipped with an electronic ignition system and an ASME rated T&P relief valve. This water heater shall have a premix closed combustion system for venting 3" (76mm), 4" (102mm), or 6" (152mm) PVC, CPVC, Polypropylene, Stainless Steel, or ABS vent pipe. Common venting options with approved kits. This water heater shall be equipped with BMS integration capabilities. The water heater shall be factory assembled and tested. The water heater shall be approved for zero inch clearance to combustibles. A digital LCD display shall be integrated into the front and be an adjustable electronic thermostat to any temperature up to 180°F. A recycling Energy Cut Off (E.C.O.) shuts off all gas in the event of an overheat condition. The entire installation shall be made in compliance with state and local codes and ordinances.

General

All gas water heaters are certified at 300 PSI test pressure (2068 kPa) and 150 PSI working pressure (1034 kPa). All models design-certified by CSA International (formerly AGA/CGA) to ANSI standard Z21.10.3, for up to 180°F (82°C) application as an Automatic Storage Heater. As an Automatic Storage Heater, all models are complete, self-contained water heating systems. It needs no separate storage tank, pump, wiring or elaborate piping network. When equipped with a mixing valve, it will supply 180°F (82°C) sanitizing and lower temperature general purpose hot water simultaneously. These models can be used either as a single unit or in multiples connected in series or parallel (recommended).

Dimensions and specifications subject to change without notice in accordance with our policy of continuous product improvement.

— BRADFORD WHITE IS —

**AMERICAN
STRONG**

Sales: 800-523-2931 ■ **Fax** 215-641-1612

24/7 Technical Support: 800-334-3393 ■ **Email** techserv@bradfordwhite.com

Products made by Bradford White are manufactured in the United States using the finest raw materials and components from around the world.

Built to be the Best®