



**BRADFORD WHITE**<sup>®</sup>  
W A T E R H E A T E R S

**COMMERCIAL ELECTRIC ENERGY SAVER REPLACEMENT  
PARTS LIST**  
**ASME Series**



(50A model shown)

**Models Covered:**

6A-kW-3  
12A-kW-3  
20A-kW-3  
30A-kW-3  
40A-kW-3  
50A-kW-3  
80A-kW-3  
120A-kW-3

\*Denotes warranty year

**Effective: January, 2023**  
**ECO 8248-3**

**NOTE: BOTH MODEL AND SERIAL  
NUMBERS ARE REQUIRED FOR  
ORDERING REPLACEMENT PARTS**

Dimensions and specifications  
subject to change without notice.

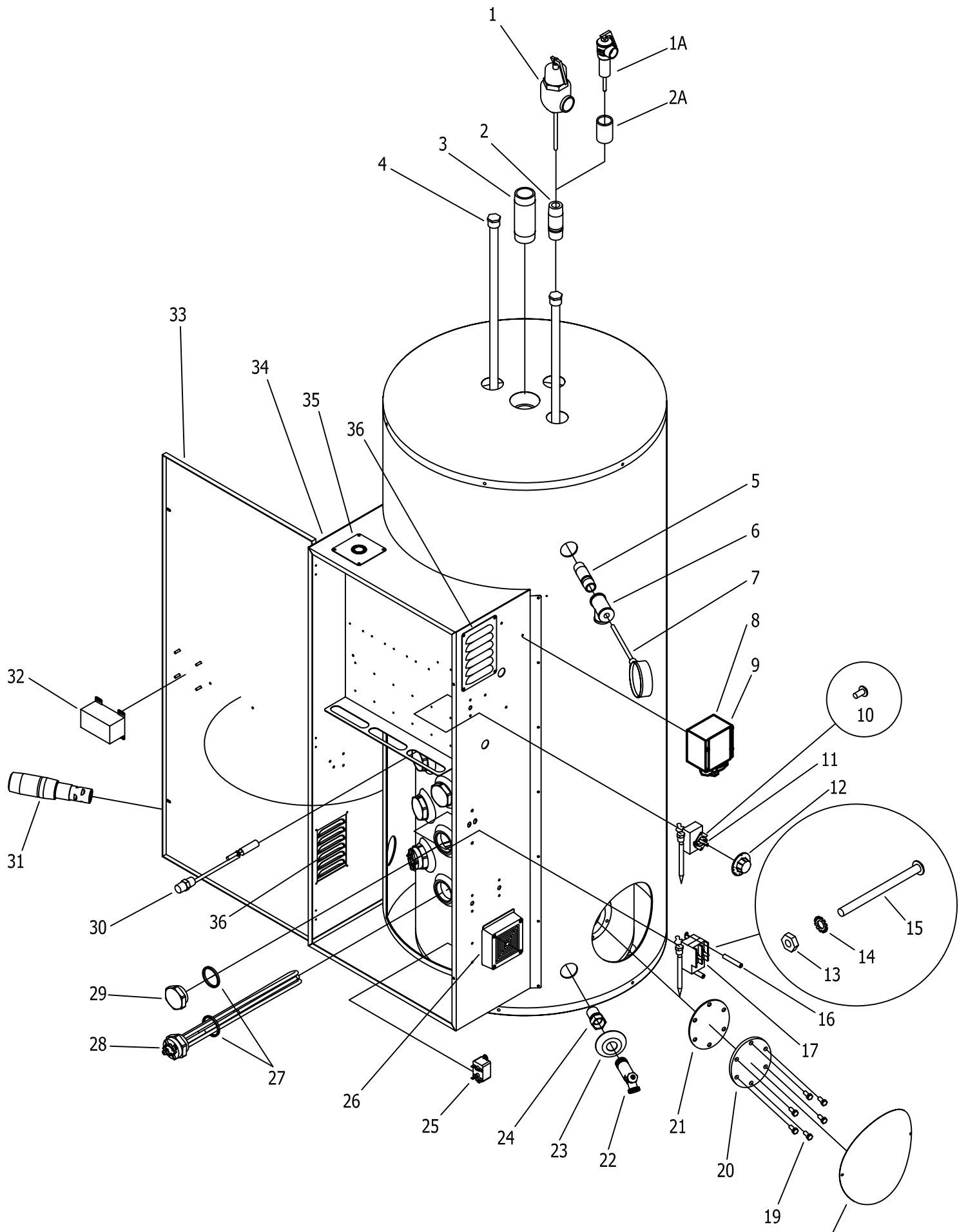

**WARNING**  
CANCER AND REPRODUCTIVE HARM  
[WWW.P65WARNINGS.CA.GOV](http://WWW.P65WARNINGS.CA.GOV)

As required by the state of California Proposition 65.

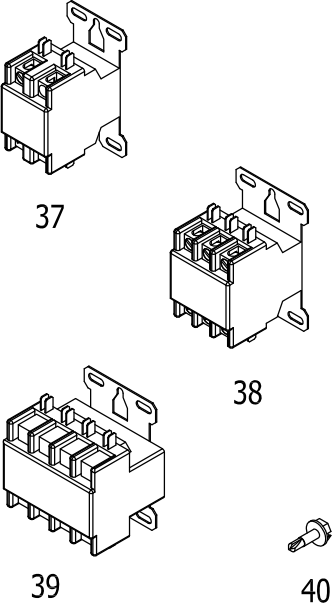
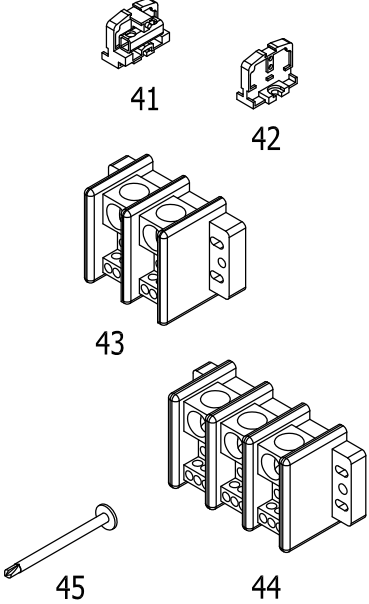
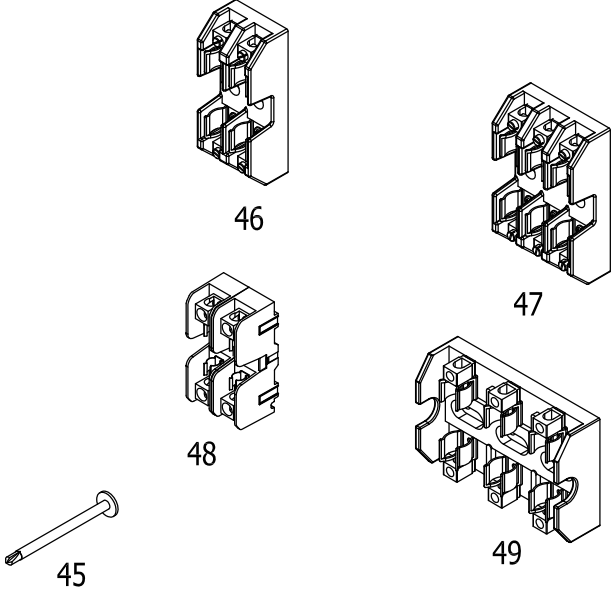
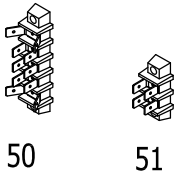
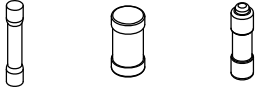

Item	Description	Model	Model	Model	Model
		6A-kW-3	12A-kW-3	20A-kW-3	30A-kW-3
1	T&P Relief Valve (Female Threads)	---	---	---	230-30246-00 (3/4"NPT)
1A	T&P Relief Valve (Male Threads)	230-32920-04 (3/4"NPT)	230-32920-04 (3/4"NPT)	230-32920-04 (3/4"NPT)	---
2	Nipple-Plastisert	---	---	---	229-32762-03
2A	Coupling	239-46679-00	239-46679-00	239-46679-00	---
3	Hot Water Outlet Nipple-Plastisert	229-32762-03	229-32762-03	229-32762-03	229-32762-03
4	Magnesium Anode Rod	415-47782-01	415-47782-01	415-47782-02	415-47782-04
	Aluminum Anode Rod	415-38508-08	415-38508-08	415-38508-02	415-38508-04
	Aluminum Anode Rod (A420)#	415-49559-04	415-49559-04	415-49559-04	415-49559-04
5	Nipple 3/4 NPT X 1-3/8 Galvanized	239-81075-00	239-81075-00	239-81075-00	---
	Nipple 3/4 NPT X 3-1/2 Plastisert	---	---	---	---
6	Galvanized Tee 3/4 X 1/2 X 1/2 NPT	239-41925-00	239-41925-00	239-41925-00	239-41925-00
7	Combination T&P Gage (Optional)	264-41987-00	264-41987-00	264-41987-00	264-41987-00
8	Pressure Switch (High) (Optional)	264-42004-01	264-42004-01	264-42004-01	264-42004-01
9	Pressure Switch (Low) (Optional)	264-42044-02	264-42044-02	264-42044-02	264-42044-02
10	Screw #6-32 X 1/4	264-81722-00 (Qty. 2)	264-81722-00 (Qty. 2)	264-81722-00 (Qty. 2)	264-81722-00 (Qty. 2)
11	Immersion Thermostat	264-33460-00	264-33460-00	264-33460-00	264-33460-00
12	Thermostat Dial	264-33459-00	264-33459-00	264-33459-00	264-33459-00
13	Hex Nut #10-32	239-34049-00 (Qty. 2)	239-34049-00 (Qty. 2)	239-34049-00 (Qty. 2)	239-34049-00 (Qty. 2)
14	External Tooth Washer #10	239-81540-00 (Qty. 2)	239-81540-00 (Qty. 2)	239-81540-00 (Qty. 2)	239-81540-00 (Qty. 2)
15	Screw #10-32 X 2 1/2	239-34048-00 (Qty. 2)	239-34048-00 (Qty. 2)	239-34048-00 (Qty. 2)	239-34048-00 (Qty. 2)
16	High Limit Spacer	264-34190-00 (Qty. 2)	264-34190-00 (Qty. 2)	264-34190-00 (Qty. 2)	264-34190-00 (Qty. 2)
17	High Limit Switch	264-33461-00	264-33461-00	264-33461-00	264-33461-00
18	Cleanout Cover (Jacket)	---	---	243-42497-00	243-42497-00
19	Cleanout Screw 5/16-18 X 3/4	---	---	239-32970-00 (Qty. 6)	239-32970-00 (Qty. 6)
20	Cleanout Cover (Tank)	---	---	205-32941-00	205-32941-00
21	Cleanout Gasket	---	---	205-32942-00	205-32942-00
22	Brass Drain Valve	415-42351-04	415-42351-04	415-42351-04	415-42351-04
23	Finished Flange 2 7/8 O.D.	---	---	---	---
24	Extender 3/4 X 2	---	---	---	---
25	Alarm Horn Relay (Optional)	264-42002-00	264-42002-00	264-42002-00	264-42002-00
26	Alarm Horn (Optional)	264-42001-00	264-42001-00	264-42001-00	264-42001-00
27	Heating Element Gasket	223-42016-00	223-42016-00	223-42016-00	223-42016-00
28	Heating Element	See Element Table	See Element Table	See Element Table	See Element Table
29	Heating Element Plug	223-42015-00	223-42015-00	223-42015-00	223-42015-00
30	Low Water Switch (Optional)	264-42000-00	264-42000-00	264-42000-00	264-42000-00
31	Cold Water Inlet Nipple	229-45268-00	229-45268-00	229-45268-00	229-45268-00
32	Electrical Door Lock (Optional)	264-42003-00	264-42003-00	264-42003-00	264-42003-00
33	Control Box Door	239-41944-00	239-41945-00	239-41946-00	239-41947-00
34	Control Box	239-42659-00	239-42660-00	239-42661-00	239-42663-00
35	Knockout Plate (Small)	239-41966-00	239-41966-00	239-41966-00	239-41966-00
	Knockout Plate (Large)	239-41967-00	239-41967-00	239-41967-00	239-41967-00
36	Louver Plate	239-41963-00	239-41963-00	239-41963-00	239-41963-00

# A420 Anode may need to be cut to length

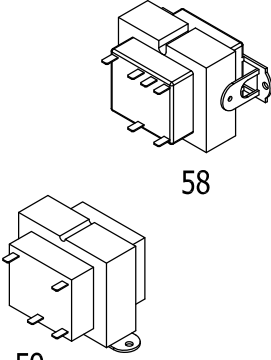
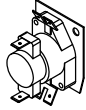

<p style="text-align: center;"><b>CONTACTORS</b></p>  <p style="text-align: center;">37 38 39 40</p>	<p style="text-align: center;"><b>TERMINAL BLOCKS</b></p>  <p style="text-align: center;">41 42 43 44 45</p>	<p style="text-align: center;"><b>FUSE BLOCKS</b></p>  <p style="text-align: center;">46 47 48 49 45</p>	
<p style="text-align: center;"><b>TERMINAL STRIPS</b></p>  <p style="text-align: center;">50 51</p>	<p style="text-align: center;"><b>FUSES</b></p>  <p style="text-align: center;">52 53 54</p> <p style="text-align: center;"><b>GROUND LUGS</b></p>  <p style="text-align: center;">55 56 57</p>	<p style="text-align: center;"><b>TRANSFORMERS</b></p>  <p style="text-align: center;">58 59</p>	<p style="text-align: center;"><b>SEQUENCERS</b></p>  <p style="text-align: center;">60</p>

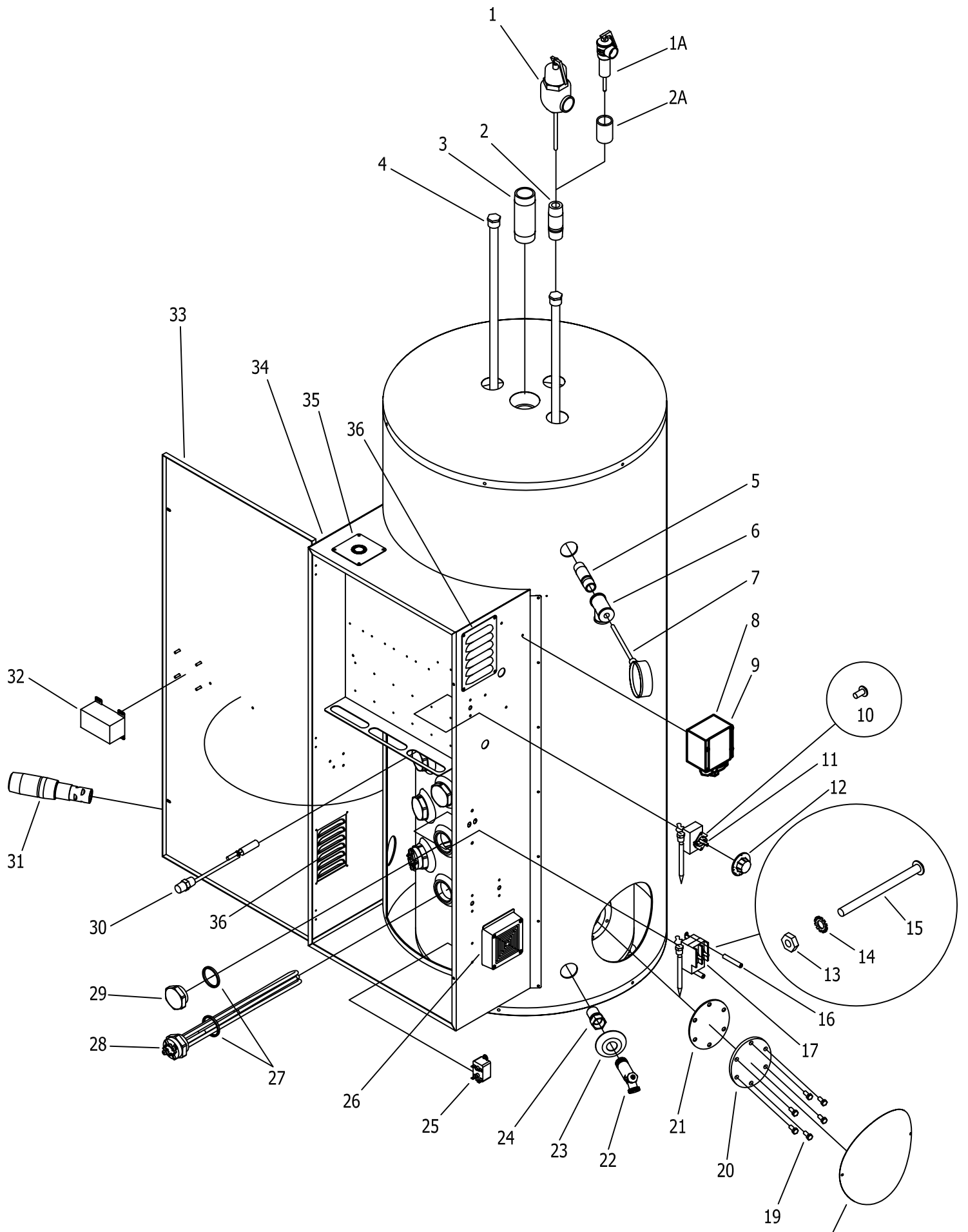
Item	Description	Model	Model	Model	Model
		6A-kW-3	12A-kW-3	20A-kW-3	30A-kW-3
37	Contacteur 2 Pole (35A)	264-41986-01	264-41986-01	264-41986-01	264-41986-01
	Contacteur 2 Pole (50A)	264-41986-02	264-41986-02	264-41986-02	264-41986-02
38	Contacteur 3 Pole (35A)	264-41988-01	264-41988-01	264-41988-01	264-41988-01
	Contacteur 3 Pole (50A)	264-41988-02	264-41988-02	264-41988-02	264-41988-02
39	Contacteur 4 Pole (35A)	264-41989-01	264-41989-01	264-41989-01	264-41989-01
	Contacteur 4 Pole (50A)	264-41989-02	264-41989-02	264-41989-02	264-41989-02
40	Screw #8-18 X 1/2	239-32761-00	239-32761-00	239-32761-00	239-32761-00
41	Terminal Block (Block A)	264-32240-00	264-32240-00	264-32240-00	264-32240-00
42	Terminal Block End (Use for Block A)	264-32241-00	264-32241-00	264-32241-00	264-32241-00
43	Terminal Block (2 Pole)	264-32244-00	264-32244-00	264-32244-00	264-32244-00
44	Terminal Block (3 Pole)	264-32245-00	264-32245-00	264-32245-00	264-32245-00
45	Screw #8-18 X 1 1/2	264-34197-00	264-34197-00	264-34197-00	264-34197-00
46	Fuse Block 2 Pole G Class (60A, 480V)	264-32263-00	264-32263-00	264-32263-00	264-32263-00
47	Fuse Block 3 Pole G Class (60A, 480V)	264-32264-00	264-32264-00	264-32264-00	264-32264-00
48	Fuse Block 2 Pole CC Class (3A, 600V)	264-53307-00	264-53307-00	264-53307-00	264-53307-00
49	Fuse Block 3 Pole T Class (60A, 600V)	264-41975-00	264-41975-00	264-41975-00	264-41975-00
	Fuse Block 3 Pole T Class (30A, 600V)	264-42568-00	264-42568-00	264-42568-00	264-42568-00
50	Terminal Strip (5 Post)	264-42006-00	264-42006-00	264-42006-00	264-42006-00
51	Terminal Strip (2 Post)	264-42007-00	264-42007-00	264-42007-00	264-42007-00
52	Fuse G Class (40A)	264-32267-00	264-32267-00	264-32267-00	264-32267-00
	Fuse G Class (50A)	264-32268-00	264-32268-00	264-32268-00	264-32268-00
	Fuse G Class (60A)	264-32269-00	264-32269-00	264-32269-00	264-32269-00
53	Fuse T Class (30A)	264-41976-01	264-41976-01	264-41976-01	264-41976-01
	Fuse T Class (40A)	264-41976-02	264-41976-02	264-41976-02	264-41976-02
	Fuse T Class (50A)	264-41976-03	264-41976-03	264-41976-03	264-41976-03
54	Fuse CC Class (3A)	264-53306-00	264-53306-00	264-53306-00	264-53306-00
55	Ground Lug Large (Wire Range 8-1/0)	264-32250-00	264-32250-00	264-32250-00	264-32250-00
56	Ground Lug Small (Wire Range 14-8)	264-32251-00	264-32251-00	264-32251-00	264-32251-00
57	Screw #10-32 X 1/2	239-33938-0	239-33938-0	239-33938-0	239-33938-0
58	Control Circuit Transformer 60va (208/240/480 VAC)	415-41994-01	415-41994-01	415-41994-01	415-41994-01
	Control Circuit Transformer 60va (277/380/415 VAC)	415-41994-02	415-41994-02	415-41994-02	415-41994-02
59	Control Circuit Transformer 60va (600 VAC)	415-41996-00	415-41996-00	415-41996-00	415-41996-00
60	Time Delay Sequencer	264-41997-00	264-41997-00	264-41997-00	264-41997-00

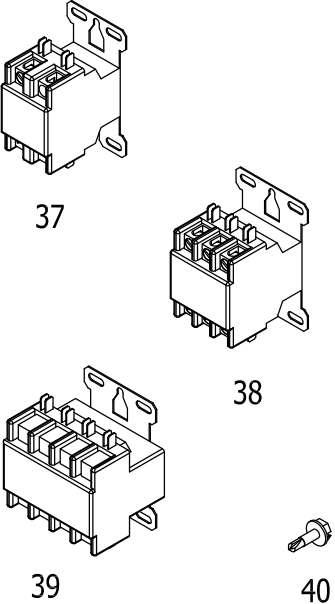
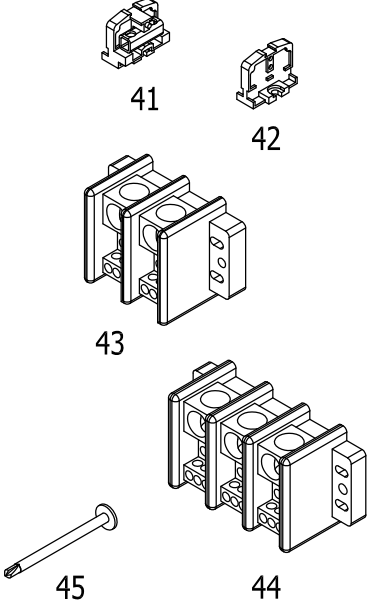
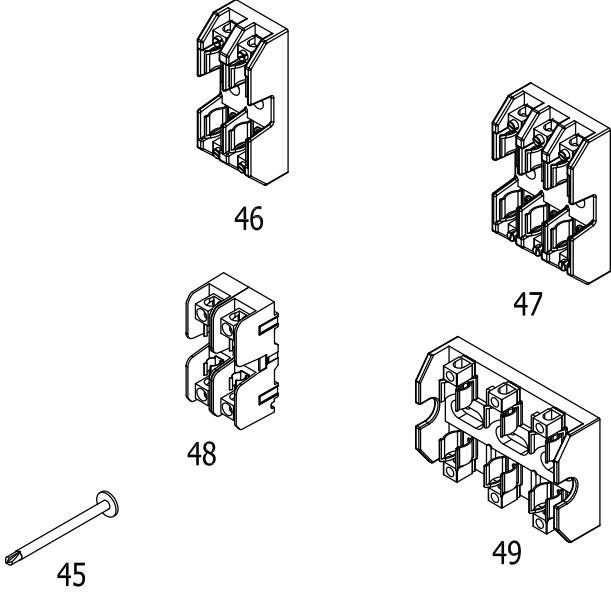
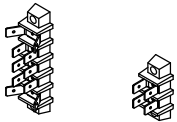
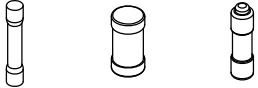

Item	Description	Model 6A-kW-3	Model 12A-kW-3	Model 20A-kW-3	Model 30A-kW-3
Item	Description	Model 40A-kW-3	Model 50A-kW-3	Model 80A-kW-3	Model 120A-kW-3
1	T&P Relief Valve (Female Threads)	230-30246-00 (3/4" NPT)	230-33630-04 (1" NPT)	230-33630-04 (1" NPT)	230-33630-04 (1" NPT)
1A	T&P Relief Valve (Male Threads)	---	---	---	---
2	Nipple-Plastisert	229-32762-03	229-32762-21	229-32762-20	229-32762-21
2A	Coupling	---	---	---	---
3	Hot Water Outlet Nipple-Plastisert	229-32762-03	229-40913-06	229-40913-06	229-40913-06
4	Magnesium Anode Rod	415-47782-06	224-47782-06 (Qty. 2)	224-47782-08 (Qty. 2)	224-47782-08 (Qty. 2)
	Aluminum Anode Rod	415-38508-03	224-38508-03 (Qty. 2)	224-38508-07 (Qty. 2)	224-38508-07 (Qty. 2)
	Aluminum Anode Rod (A420)#	415-49559-04	415-49559-04	415-49559-04	415-49559-04
5	Nipple 3/4 NPT X 1-3/8 Galvanized	---	---	---	---
	Nipple 3/4 NPT X 3-1/2 Plastisert	---	229-32762-08	229-32762-08	229-32762-08
6	Galvanized Tee 3/4 X 1/2 X 1/2 NPT	239-41925-00	239-41925-00	239-41925-00	239-41925-00
7	Combination T&P Gage (Optional)	264-41987-00	264-41987-00	264-41987-00	264-41987-00
8	Pressure Switch (High) (Optional)	264-42004-01	264-42004-01	264-42004-01	264-42004-01
9	Pressure Switch (Low) (Optional)	264-42004-02	264-42004-02	264-42004-02	264-42004-02
10	Screw #6-32 X 1/4	264-81722-00 (Qty. 2)	264-81722-00 (Qty. 2)	264-81722-00 (Qty. 2)	264-81722-00 (Qty. 2)
11	Immersion Thermostat	264-33460-00	264-33460-00	264-33460-00	264-33460-00
12	Thermostat Dial	264-33459-00	264-33459-00	264-33459-00	264-33459-00
13	Hex Nut #10-32	239-34049-00 (Qty. 2)	239-34049-00 (Qty. 2)	239-34049-00 (Qty. 2)	239-34049-00 (Qty. 2)
14	External Tooth Washer #10	239-81540-00 (Qty. 2)	239-81540-00 (Qty. 2)	239-81540-00 (Qty. 2)	239-81540-00 (Qty. 2)
15	Screw #10-32 X 2 1/2	239-34048-00 (Qty. 2)	239-34048-00 (Qty. 2)	239-34048-00 (Qty. 2)	239-34048-00 (Qty. 2)
16	High Limit Spacer	264-34190-00 (Qty. 2)	264-34190-00 (Qty. 2)	264-34190-00 (Qty. 2)	264-34190-00 (Qty. 2)
17	High Limit Switch	264-33461-00	264-33461-00	264-33461-00	264-33461-00
18	Cleanout Cover (Jacket)	243-42497-00	243-20299-00	243-20299-00	243-20299-00
19	Cleanout Screw 5/16-18 X 3/4	239-32970-00 (Qty. 6)	239-32970-00 (Qty. 6)	239-32970-00 (Qty. 6)	239-32970-00 (Qty. 6)
20	Cleanout Cover (Tank)	205-32941-00	205-32941-00	205-32941-00	205-32941-00
21	Cleanout Gasket	205-32942-00	205-32942-00	205-32942-00	205-32942-00
22	Brass Drain Valve	415-42351-04	415-42351-04	415-42351-04	415-42351-04
23	Finished Flange 2 7/8 O.D.	---	239-41414-00	239-41414-00	239-41414-00
24	Extender 3/4 X 2	---	229-19100-00	229-19100-00	229-19100-00
25	Alarm Horn Relay (Optional)	264-42002-00	264-42002-00	264-42002-00	264-42002-00
26	Alarm Horn (Optional)	264-42001-00	264-42001-00	264-42001-00	264-42001-00
27	Heating Element Gasket	223-42016-00	223-42016-00	223-42016-00	223-42016-00
28	Heating Element	See Element Table	See Element Table	See Element Table	See Element Table
29	Heating Element Plug	223-42015-00	223-42015-00	223-42015-00	223-42015-00
30	Low Water Switch (Optional)	264-42000-00	264-42000-00	264-42000-00	264-42000-00
31	Cold Water Inlet Nipple	229-45268-00	415-44731-00	415-44731-00	415-44731-00
32	Electrical Door Lock (Optional)	264-42003-00	264-42003-00	264-42003-00	264-42003-00
33	Control Box Door	239-41947-00	239-42105-00	239-42105-00	239-42105-00
34	Control Box	239-42663-00	239-42106-00	239-42107-00	239-42108-00
35	Knockout Plate (Small)	239-41966-00	239-41966-00	239-41966-00	239-41966-00
	Knockout Plate (Large)	239-41967-00	239-41967-00	239-41967-00	239-41967-00
36	Louver Plate	239-41963-00	239-41963-00	239-41963-00	239-41963-00

# A420 Anode may need to be cut to length

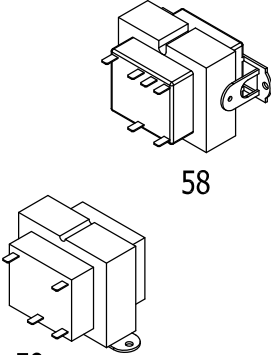
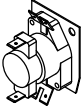
<p style="text-align: center;"><b>CONTACTORS</b></p>  <p style="text-align: center;">37 38 39 40</p>	<p style="text-align: center;"><b>TERMINAL BLOCKS</b></p>  <p style="text-align: center;">41 42 43 44 45</p>	<p style="text-align: center;"><b>FUSE BLOCKS</b></p>  <p style="text-align: center;">46 47 48 49 45</p>	
<p style="text-align: center;"><b>TERMINAL STRIPS</b></p>  <p style="text-align: center;">50 51</p>	<p style="text-align: center;"><b>FUSES</b></p>  <p style="text-align: center;">52 53 54</p> <p style="text-align: center;"><b>GROUND LUGS</b></p>  <p style="text-align: center;">55 56 57</p>	<p style="text-align: center;"><b>TRANSFORMERS</b></p>  <p style="text-align: center;">58 59</p>	<p style="text-align: center;"><b>SEQUENCERS</b></p>  <p style="text-align: center;">60</p>



Item	Description	Model	Model	Model	Model
		6A-kW-3	12A-kW-3	20A-kW-3	30A-kW-3
37	Contacteur 2 Pole (35A)	264-41986-01	264-41986-01	264-41986-01	264-41986-01
	Contacteur 2 Pole (50A)	264-41986-02	264-41986-02	264-41986-02	264-41986-02
38	Contacteur 3 Pole (35A)	264-41988-01	264-41988-01	264-41988-01	264-41988-01
	Contacteur 3 Pole (50A)	264-41988-02	264-41988-02	264-41988-02	264-41988-02
39	Contacteur 4 Pole (35A)	264-41989-01	264-41989-01	264-41989-01	264-41989-01
	Contacteur 4 Pole (50A)	264-41989-02	264-41989-02	264-41989-02	264-41989-02
40	Screw #8-18 X 1/2	239-32761-00	239-32761-00	239-32761-00	239-32761-00
41	Terminal Block (Block A)	264-32240-00	264-32240-00	264-32240-00	264-32240-00
42	Terminal Block End (Use for Block A)	264-32241-00	264-32241-00	264-32241-00	264-32241-00
43	Terminal Block (2 Pole)	264-32244-00	264-32244-00	264-32244-00	264-32244-00
44	Terminal Block (3 Pole)	264-32245-00	264-32245-00	264-32245-00	264-32245-00
45	Screw #8-18 X 1 1/2	264-34197-00	264-34197-00	264-34197-00	264-34197-00
46	Fuse Block 2 Pole G Class (60A, 480V)	264-32263-00	264-32263-00	264-32263-00	264-32263-00
47	Fuse Block 3 Pole G Class (60A, 480V)	264-32264-00	264-32264-00	264-32264-00	264-32264-00
48	Fuse Block 2 Pole CC Class (3A, 600V)	264-53307-00	264-53307-00	264-53307-00	264-53307-00
49	Fuse Block 3 Pole T Class (60A, 600V)	264-41975-00	264-41975-00	264-41975-00	264-41975-00
	Fuse Block 3 Pole T Class (30A, 600V)	264-42568-00	264-42568-00	264-42568-00	264-42568-00
50	Terminal Strip (5 Post)	264-42006-00	264-42006-00	264-42006-00	264-42006-00
51	Terminal Strip (2 Post)	264-42007-00	264-42007-00	264-42007-00	264-42007-00
52	Fuse G Class (40A)	264-32267-00	264-32267-00	264-32267-00	264-32267-00
	Fuse G Class (50A)	264-32268-00	264-32268-00	264-32268-00	264-32268-00
	Fuse G Class (60A)	264-32269-00	264-32269-00	264-32269-00	264-32269-00
53	Fuse T Class (30A)	264-41976-01	264-41976-01	264-41976-01	264-41976-01
	Fuse T Class (40A)	264-41976-02	264-41976-02	264-41976-02	264-41976-02
	Fuse T Class (50A)	264-41976-03	264-41976-03	264-41976-03	264-41976-03
54	Fuse CC Class (3A)	264-53306-00	264-53306-00	264-53306-00	264-53306-00
55	Ground Lug Large (Wire Range 8-1/0)	264-32250-00	264-32250-00	264-32250-00	264-32250-00
56	Ground Lug Small (Wire Range 14-8)	264-32251-00	264-32251-00	264-32251-00	264-32251-00
57	Screw #10-32 X 1/2	239-33938-00	239-33938-00	239-33938-00	239-33938-00
58	Control Circuit Transformer 60va (208/240/480 VAC)	415-41994-01	415-41994-01	415-41994-01	415-41994-01
	Control Circuit Transformer 60va (277/380/415 VAC)	415-41994-02	415-41994-02	415-41994-02	415-41994-02
59	Control Circuit Transformer 60va (600 VAC)	415-41996-00	415-41996-00	415-41996-00	415-41996-00
60	Time Delay Sequencer	264-41997-00	264-41997-00	264-41997-00	264-41997-00

Heating Elements (Incoloy) for:  
Commercial "A" ASME Series

Wattage	208 Volt	240 Volt	277 Volt	380Volt
1000W ▲	---	---	---	---
2000W ▲	415-41985-01	415-41985-08	415-41985-15	415-41985-43
3000W ▲ ▲	415-41985-02	415-41985-09	415-41985-16	415-41985-44
4000W*	415-41985-03	415-41985-10	415-41985-17	415-41985-45
4500W*	415-41985-13	415-41985-11	415-41985-18	415-41985-46
5000W*	415-41985-05	415-41985-12	415-41985-19	415-41985-47
6000W*	415-41985-06	415-41985-13	415-41985-20	415-41985-57
9000W**	415-41985-51	415-41985-52	415-41985-53	415-41985-50

Wattage	400 Volt	415 Volt	480 Volt	600 Volt
1000W ▲	415-41985-58	---	---	---
2000W ▲	415-41985-59	415-41985-22	415-41985-29	415-41985-36
3000W ▲ ▲	415-41985-60	415-41985-23	415-41985-30	415-41985-37
4000W*	415-41985-61	415-41985-24	415-41985-31	415-41985-38
4500W*	415-41985-62	415-41985-25	415-41985-32	415-41985-39
5000W*	---	415-41985-26	415-41985-33	415-41985-40
6000W*	---	415-41985-27	415-41985-34	415-41985-41
9000W**	---	415-41985-54	415-41985-55	415-41985-56

- ▲ For 12" diameter tanks and above.
- ▲▲ For 14" diameter tanks and above.
- \* For 16" diameter tanks and above.
- \*\* For 18" diameter tanks and above.

### **Reference Chart of Anode Length by Model**

Model	Hex Head Anode Cut Length (End to end)	
	Inches	Millimeters
6A-kW-3	9.5	241
12A-kW-3	17.5	445
20A-kW-3	17.5	445
30A-kW-3	32	813
40A-kW-3	40	1016
50A-kW-3	40	1016
80A-kW-3	47	1194
120A-kW-3	47	1194



## United States

---

**Sales** 800-523-2931

**Technical Support** 800-334-3393

**Email** [techserv@bradfordwhite.com](mailto:techserv@bradfordwhite.com)

**Warranty** 800-531-2111

**Email** [warranty@bradfordwhite.com](mailto:warranty@bradfordwhite.com)

**Service Parts** 800-538-2020

**Email** [parts@bradfordwhite.com](mailto:parts@bradfordwhite.com)

## Canada

---

**Sales & Technical Support** 866-690-0961 905-203-0600

**Fax** 905-636-0666

**Warranty** [bwccwarranty@bradfordwhite.com](mailto:bwccwarranty@bradfordwhite.com)

**Technical Support** [bwccotech@bradfordwhite.com](mailto:bwccotech@bradfordwhite.com)

**Service Parts** [orders@bradfordwhitecanada.com](mailto:orders@bradfordwhitecanada.com)

**Orders** [ca.orders@bradfordwhite.com](mailto:ca.orders@bradfordwhite.com)

For U.S. and Canada field service,  
contact your professional installer or  
local Bradford White sales representative.

## International

---

**General Contact** [international@bradfordwhite.com](mailto:international@bradfordwhite.com)